



# Precision Camshafts Limited

(100% EOU Division)

Works : D-5,D-6,7,7-1, MID C, Chincholi, Solapur 413 255.



Sec/Aug/SE/N&B/01

**Date:** 02<sup>nd</sup> August, 2016

**BSE Limited,**

**The National Stock Exchange of India Limited**

Phiroze Jeejeebhoy Towers,  
Dalal Street, Mumbai - 400001

Exchange Plaza, Bandra kurla Complex,  
Bandra (E) Mumbai 400051

Dear Sirs,

**Sub:- Intimation of Analyst/Brokers Meeting under regulation 30 (6) of the Securities and Exchange Board of India (Listing Obligations and Disclosure Requirements) Regulations, 2015 and Investors Presentation:**

We would like to inform you that pursuant to Regulation 30 (6) of the Securities and Exchange Board of India (Listing Obligations and Disclosure Requirements) Regulations, 2015 following are the details of scheduled meetings to be held on 03<sup>rd</sup> August 2016 at Mumbai with analyst/Broker as follows:

Particulars	Type of Meeting	Time
Emkay Share & Stock Brokers Haitong Macquarie Capital Securities (India) Pvt Ltd JM Financial Institutional Securities Pvt. Ltd. Systematix Shares & Stocks Ltd.	Group Meeting	2.00 p.m. to 2.50 p.m.
Karvy Stock Broking Ltd. Kotak Securities Sharekhan Ltd. HDFC Securities Edelweiss Capital Edelweiss AMC Yes Research	Group Meeting	3.00 p.m. to 3.50 p.m.
Credit Suisse HSBC Motilal Oswal Securities Ltd. Phillip Securities Prabhudas Lilladher Pvt. Ltd. Enam Holdings Quant Broking Pvt. Ltd.	Group Meeting	4.00 p.m. to 4.50 p.m.



Further, we are submitting herewith Investors Presentation for your record.

You are kindly requested to take the same on record.

Thanking you,

Yours Truly

For **Precision Camshafts Limited**

  
**Swapneel Kuber**  
**Company Secretary**



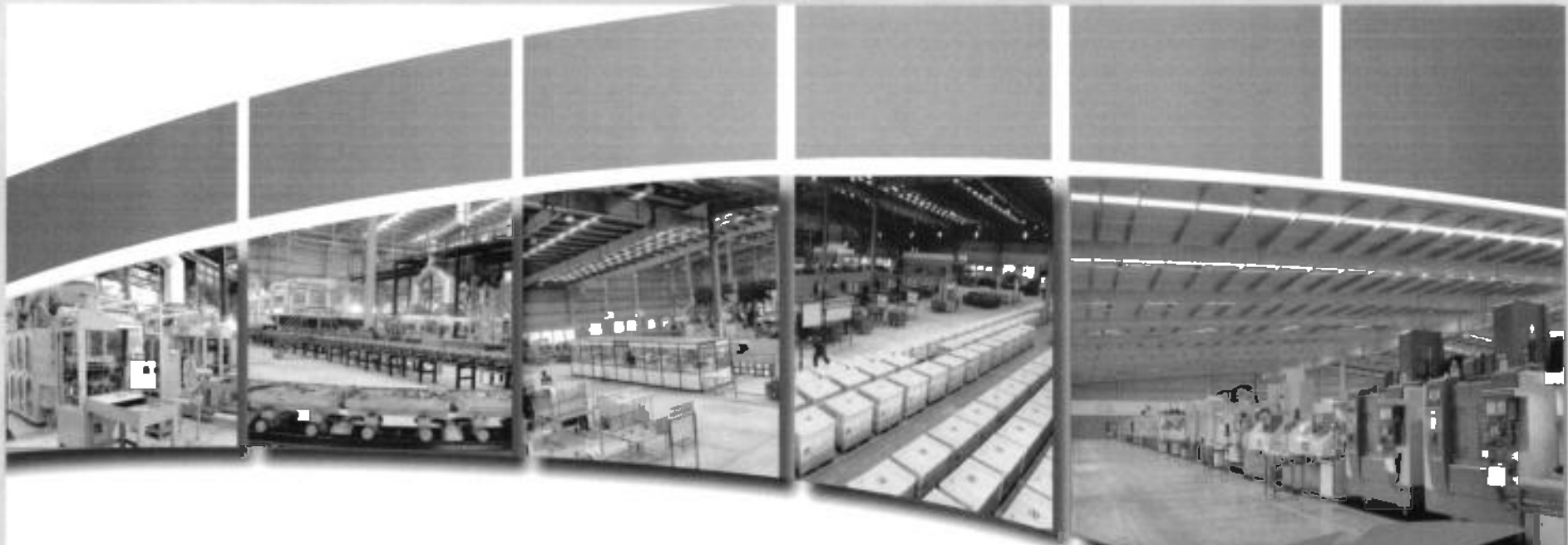

## INVESTOR PRESENTATION

JULY 2016

# PRECISION CAMSHAFTS LIMITED



## **CAMSHAFT IS ONE OF THE MOST CRITICAL COMPONENTS OF VEHICLE IC ENGINE**

- **Camshaft and its associated parts control the functioning of an internal combustion engine**
- **Camshaft design governs the engine's power, efficiency, mileage and emission**
- **Camshaft design, manufacturing process and machining requirement vary across vehicle categories and desired engine characteristics**
- **OEMs closely work with camshaft manufacturers right from the engine platform design stage which is a long development process of circa two and half years**

## CONTINUOUS DEVELOPMENTS IN ENGINE TECHNOLOGY ARE EXPANDING OPPORTUNITIES FOR CAMSHAFT MANUFACTURERS

- Engine technology is undergoing continuous developments –

- Improvement in engine efficiency and performance

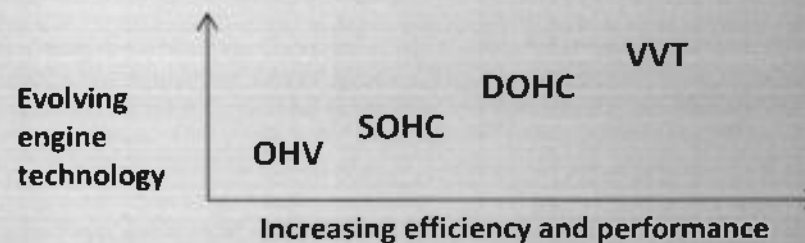

- Compliance with stricter emission norms

Euro emission norms					
1992	1996	2000	2005	2009	2014
Euro 1	Euro 2	Euro 3	Euro 4	Euro 5	Euro 6

- Constant engine technology developments create new opportunities for camshaft manufacturers

**OEMs ARE INCREASINGLY OUTSOURCING CAMSHAFT MANUFACTURING  
HOWEVER, STRINGENT APPROVAL PROCESS LIMITS THE NUMBER OF SUPPLIERS**

- **Camshaft manufacturing process is highly capital intensive with long gestation period**
- **OEM's source from suppliers with demonstrated technological and manufacturing capabilities**
- **Camshaft design and profile are very critical for the engine performance; hence OEMs follow a very stringent approval process**
- **As a result, there are very limited suppliers who work with the global OEMs**

## PRECISION CAMSHAFTS IS THE LEADING SUPPLIER OF CAMSHAFTS IN INDIA AND GLOBALLY

- PCL is one of the world's leading manufacturer and supplier of camshafts
- PCL has strong relationships with marquee global & domestic OEMs

✓ General Motors	✓ Tata Motors
✓ Ford Motors	✓ Mahindra and Mahindra
✓ Hyundai	✓ Toyota
✓ Maruti Suzuki	✓ Porsche
✓ Mercedes Benz	✓ Fiat
✓ SsangYong	✓ Diesel Locomotive Works Limited

- PCL has consistently increased its global market share in passenger vehicle camshafts from 5% - 6% in 2010 to an estimated 8% - 9% in 2014 (Source: ICRA)

## DISCLAIMER



This presentation and the following discussion may contain “forward looking statements” by Precision Camshafts Limited (“Precision Camshafts” or “PCL” or the “Company”) that are not historical in nature. These forward looking statements, which may include statements relating to future results of operations, financial condition, business prospects, plans and objectives are based on the current beliefs, assumptions, expectations, estimates and projections of the management of PCL about the business, industry and markets in which PCL operates.

These statements are not guarantees of future performance and are subject to known and unknown risks, uncertainties and other factors, some of which are beyond PCL’s control and difficult to predict, that could cause actual results, performance or achievements to differ materially from those in the forward looking statements.

Such statements are not and should not be construed as a representation of future performance or achievements of PCL. In particular, such statements should not be regarded as a projection of future performance of PCL. It should be noted that the actual performance or achievements of PCL may vary significantly from such statements.





### COMPANY OVERVIEW

- BUSINESS MODEL
- COMPETITIVE ADVANTAGES
- BUSINESS STRATEGY & OUTLOOK
- FINANCIAL OVERVIEW & SHAREHOLDING STRUCTURE



## COMPANY OVERVIEW

### PRECISION CAMSHAFTS – BRIEF PROFILE



#### BUSINESS OVERVIEW

- Incorporated in 1992, PCL is one of the leading manufacturer and supplier of camshafts in India and globally
- Global market share of 8% - 9% in passenger vehicle camshafts
- Supplies more than 150 varieties of camshafts for passenger vehicles, tractors, light commercial vehicles and locomotive engine applications
- Strong management team led by Mr. Yatin Shah and Dr. Suhasini Shah having 20+ years of experience in auto component manufacturing

#### KEY STRENGTHS

- State of art manufacturing facilities and cost competitive engineering expertise
  - EOU unit – 4 foundries and 2 machine shops, Domestic unit – 1 foundry and 1 machine shop
  - Relatively low defect rates due to strong technology, systems and processes
- Comprehensive product offering – PCL is one of the few global suppliers who manufacture all three types of camshafts i.e. cast iron, ductile iron, hybrid and assembled camshafts
- Long term relationships with marquee global OEMs - General Motors, Ford Motors, Hyundai, Maruti Suzuki, Tata Motors, Mahindra & Mahindra, Toyota, Porsche, Mercedes Benz, SsangYong etc.

#### STRONG FINANCIALS

- Consolidated Revenues, EBITDA and PAT were Rs 4,767.4 mn, Rs 1,336.7 mn and Rs 641.6 mn in FY16 having grown at CAGR of 12%, 34% and 33% respectively over FY12 to FY16.
- Strong balance sheet as on FY16 – C&CE - Rs 3,238.6 mn, Debt - Rs 2,076.4 mn, Equity - Rs 5,145.4 mn, D:E ratio - 0.4x
- Healthy Return Ratios in FY16 :
  - ROCE – 15.4%
  - ROE – 17.1%

## COMPANY OVERVIEW OUR EVOLUTION

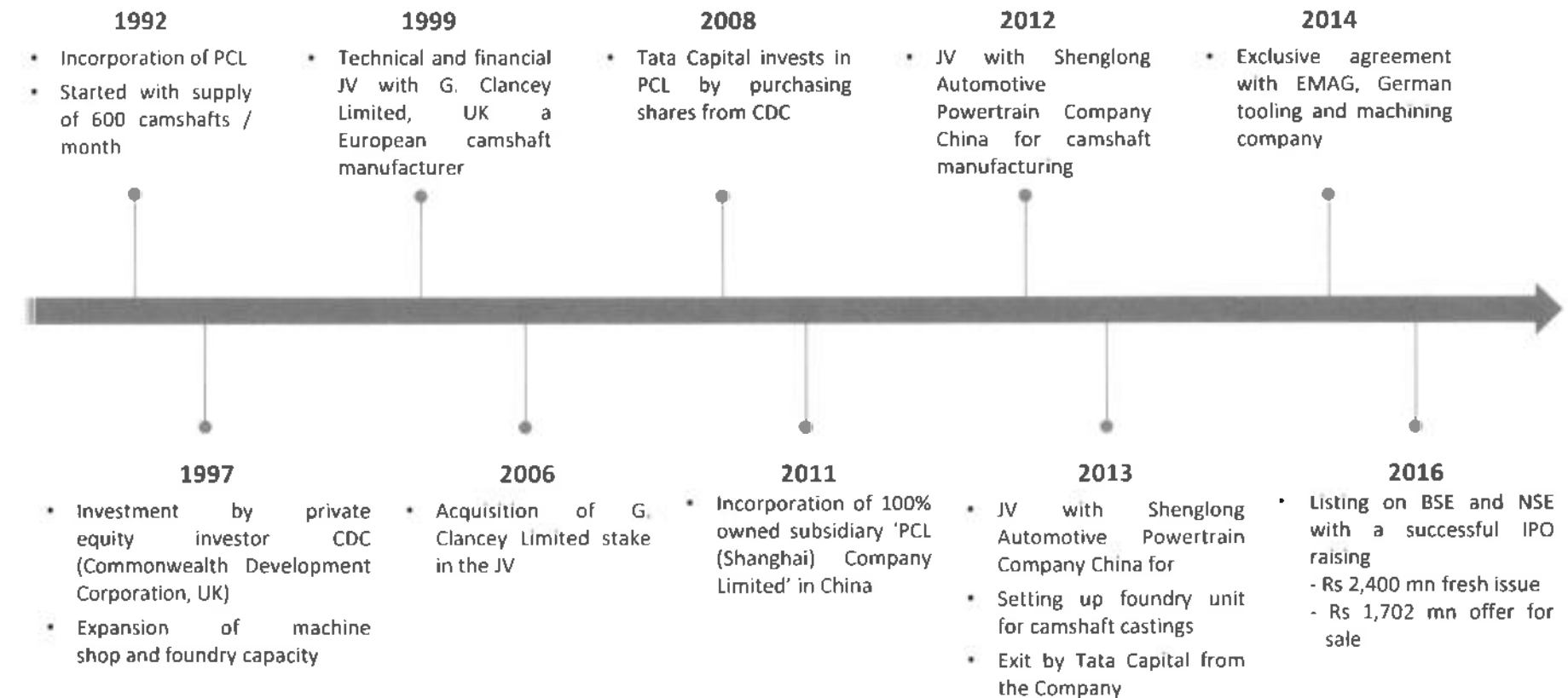

# COMPANY OVERVIEW

## MARQUEE CUSTOMERS AND GLOBAL FOOTPRINT



### MARQUEE CUSTOMERS



### GEOGRAPHICAL FOOTPRINT



- Geographies in which customers are serviced by PCL

### MARKETING NETWORK

- 4 continents serviced through various agencies –
  - KorConsulting LLC - North America, Europe and UK
  - Huppert Engineering - South America
  - T&G Auto-tec - South Korea

## COMPANY OVERVIEW BOARD OF DIRECTORS



<p><b>Mr. Yatin Shah</b> <i>Chairman &amp; Managing Director</i></p>	<ul style="list-style-type: none"> <li>• He holds a B.Com from Bombay University and a MBA from Pune University</li> <li>• Over 23 years of experience in the auto component manufacturing sector</li> <li>• Received various awards, including J.R.D. Tata Udyog Ratna Award by Maharashtra Audyogik Vikas Parishad, Pune in 2011</li> </ul>
<p><b>Dr. Suhasini Shah</b> <i>Director</i></p>	<ul style="list-style-type: none"> <li>• She holds Bachelor's degree in law, in medicine and in surgery from Shivaji University</li> <li>• She has a PGDM in medico-legal systems, Symbiosis Centre of Health Care and has participated in an executive education programme on small and medium enterprises at IIM, Ahmedabad</li> <li>• Over 23 years of work experience in management</li> </ul>
<p><b>Mr. Ravindra Rangnath Joshi</b> <i>Director &amp; CFO</i></p>	<ul style="list-style-type: none"> <li>• He holds a BCom from Bangalore University and a Diploma in Business Management from Shivaji University</li> <li>• 28 years of experience in the field of finance with various organizations</li> </ul>
<p><b>Mr. Jayant Aradhya</b> <i>Non-Executive Director</i></p>	<ul style="list-style-type: none"> <li>• He holds a Bachelor's degree in metallurgic engineering from the University of Pune and a Bachelor's degree in mechanical engineering from Marathwada University.</li> </ul>
<p><b>Mr. Sarvesh Joshi</b> <i>Independent Director</i></p>	<ul style="list-style-type: none"> <li>• He holds a Bachelor's degree in law and a Bachelor's degree in commerce from the University of Pune. He is a certified member of the Institute of Chartered Accountants of India and has been a practicing Chartered Accountant for over 27 years</li> </ul>
<p><b>Mr. Pramod Mehendale</b> <i>Independent Director</i></p>	<ul style="list-style-type: none"> <li>• He holds a Bachelor's degree in commerce and is a fellow of the ICSI. He holds a certificate of merit from the Institute of Cost and Work Accountants of India.</li> <li>• He is the founder and a former director of Link Intime India Private Limited.</li> </ul>
<p><b>Mr. Vedant Pujari</b> <i>Independent Director</i></p>	<ul style="list-style-type: none"> <li>• He holds a Bachelor's degree in commerce from Nagpur University, a bachelor's degree in law from the University of Pune and a diploma in corporate laws from Indian Law Society Pune.</li> <li>• He is a member of the Delhi High Court Bar Association</li> </ul>
<p><b>Mr. Valbhav Mahajani</b> <i>Independent Director</i></p>	<ul style="list-style-type: none"> <li>• He holds a Bachelor's degree in electronics engineering from Dnyaneshwar Vidyapeeth and has been certified by the ISACA, Pune as an Information Security Manager.</li> </ul>

## COMPANY OVERVIEW KEY MANAGEMENT



**Mr. Achyut Gadre**  
*GM, Production*

- He holds a Bachelor of Science in Engineering from Shivaji University
- Joined PCL in 1995 and has 19 years of work experience in automobile manufacturing

**Mr. Ajitkumar Jain**  
*GM, BD & Projects*

- He holds a Bachelor's degree in production engineering from VJTI, Mumbai
- Joined PCL in 2004 and has 20 years of work experience in manufacturing engineering.

**Mr. M. G. Valse**  
*GM, Design and Engineering Services*

- He has a Diploma in mechanical engineering from the Maharashtra Board of Technical Examinations
- Joined PCL in 2000 and has 34 years of work experience in product development

**Mr. Rajkumar Kashid**  
*GM, Human Resources*

- He holds a Master's degree in social welfare and an LLB degree from Shivaji University
- Joined PCL in 1995 and has 25 years of work experience in management

**Mr. Deepak Kulkarni**  
*AGM, Projects*

- He holds a Diploma in mechanical engineering
- Joined PCL in 1990 and has 25+ years of work experience in product development

**Mr. Pradeep Mahindrakar**  
*Sr. Manager, Maintenance*

- He holds a Diploma in mechanical engineering
- Has 21 years of work experience in mechanical engineering

**Mr. Swapneel Kuber**  
*CS and Compliance Officer*

- He holds a Bachelor's degree in law from Shivaji University.
- He is an associate of the Institute of Company Secretaries of India



COMPANY OVERVIEW

**BUSINESS MODEL**

COMPETITIVE ADVANTAGES

BUSINESS STRATEGY & OUTLOOK

FINANCIAL OVERVIEW &  
SHAREHOLDING STRUCTURE

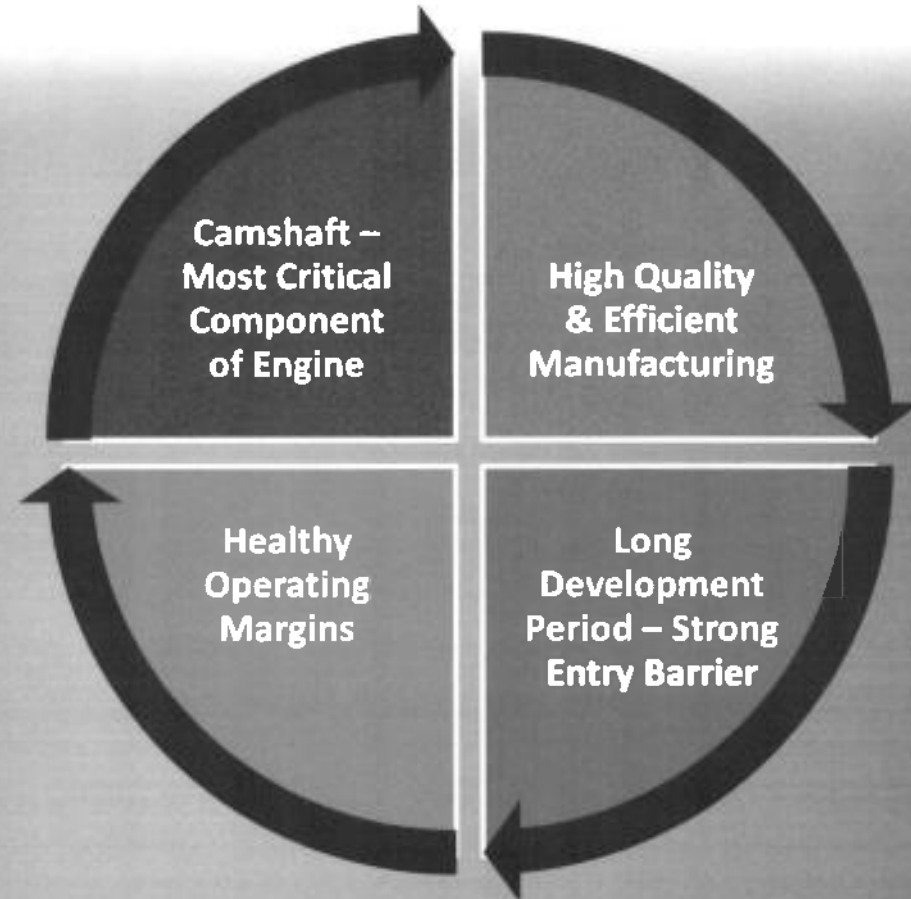

# BUSINESS MODEL

## WHAT IS CAMSHAFT?



### 5C's of IC engine

- Camshaft
- Crankshaft
- Connecting rod
- Cylinder block
- Cylinder head

### Why is camshaft critical?

Camshaft design impacts the engine's power, efficiency, mileage and emission

### How does camshaft function?

- Camshaft converts the rotary motion of the crankshaft into an oscillating motion of the engine valves
- The rotating cam lobes control the engine valves in the correct sequence, controlling the piston movement
- The camshaft in turn is driven by the crankshaft through timing gears

### What governs camshaft demand?

- Camshaft demand is dependent on automobile demand, as camshafts are required in all IC engines
- Passenger vehicles largely use either single camshaft engines (SOHC) or double camshaft engines (DOHC)
- On an average, camshaft volumes are 1.5x times the passenger vehicles produced

### Camshaft manufacturing is largely outsourced

- Camshaft manufacturing is highly capital intensive with long gestation period
- OEMs prefer to outsource the camshaft manufacturing
- OEMs prefer to source camshafts from a single supplier for a particular engine platform or a geography

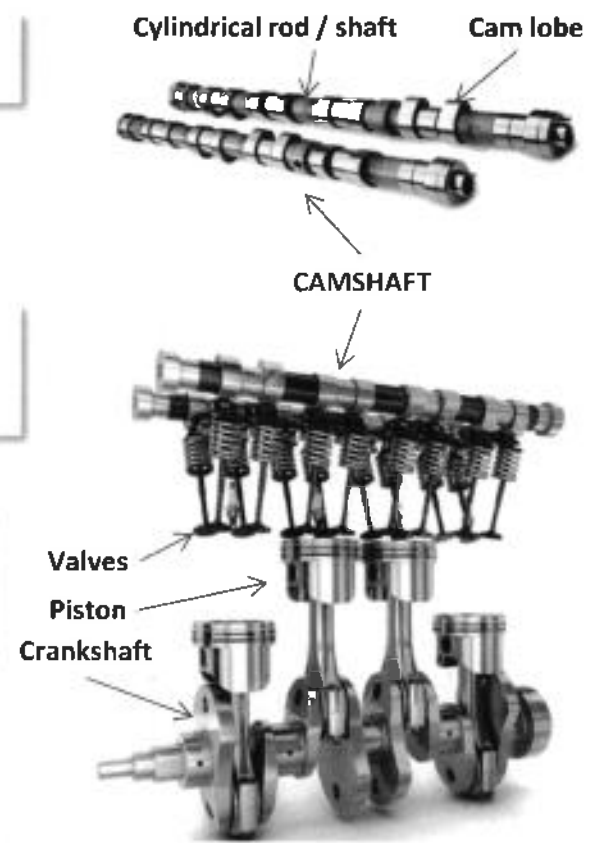



## BUSINESS MODEL CAMSHAFT MANUFACTURING TECHNOLOGIES



Process	Chilled Cast Iron Casting	Ductile Iron Casting	Assembled Camshaft
Details	<p>With the chill-cast approach, cam lobes that need local hardening have chill inserts placed in the tool. The inserts freeze the molten iron on contact, producing high-hardness microstructure formations that penetrate deep into the metal, while leaving the remainder of the camshaft with tougher, more flexible iron</p>		<p>Assembled camshafts are produced by assembling / fixing aggregate parts, i.e., lobes, journals, sprockets etc. on a tubular shaft</p>
Key Raw Material	<p>Pig Iron, M S Scrap, Resin Coated Sand (RCS), Filter</p>	<p>Pig Iron, CRCA, Low Boron Scrap, RCS, Filter</p>	<p>Different material can be used for shaft and lobes</p>
Comments	<p>Ductile iron can handle more pressure than cast iron though ease of machining and cost make chilled cast iron the preferred method Additional weight reduction can be achieved by using hollow/profiled shafts Chilled cast iron generally doesn't require additional hardening while ductile iron can require additional hardening if chills are not used</p>		<p>Provides increased design flexibility along with potential to reduce shaft weight by more than 30% providing improved fuel efficiency and lesser emissions</p>

**PRECISION CAMSHAFTS IS ONE OF THE FEW GLOBAL CAMSHAFT MANUFACTURERS  
HAVING TECHNOLOGICAL CAPABILITIES ACROSS ALL THE THREE MANUFACTURING PROCESSES**

## BUSINESS MODEL

### LONG DEVELOPMENT PERIOD – STRONG ENTRY BARRIER



Camshafts play a very critical role in impacting the overall engine performance. Hence OEMs involve camshaft manufacturers right from the engine platform design stage

#### Camshaft development process:

In case of a new engine platform under development, the OEM works along with the approved camshaft supplier for finalising the camshaft design and specifications

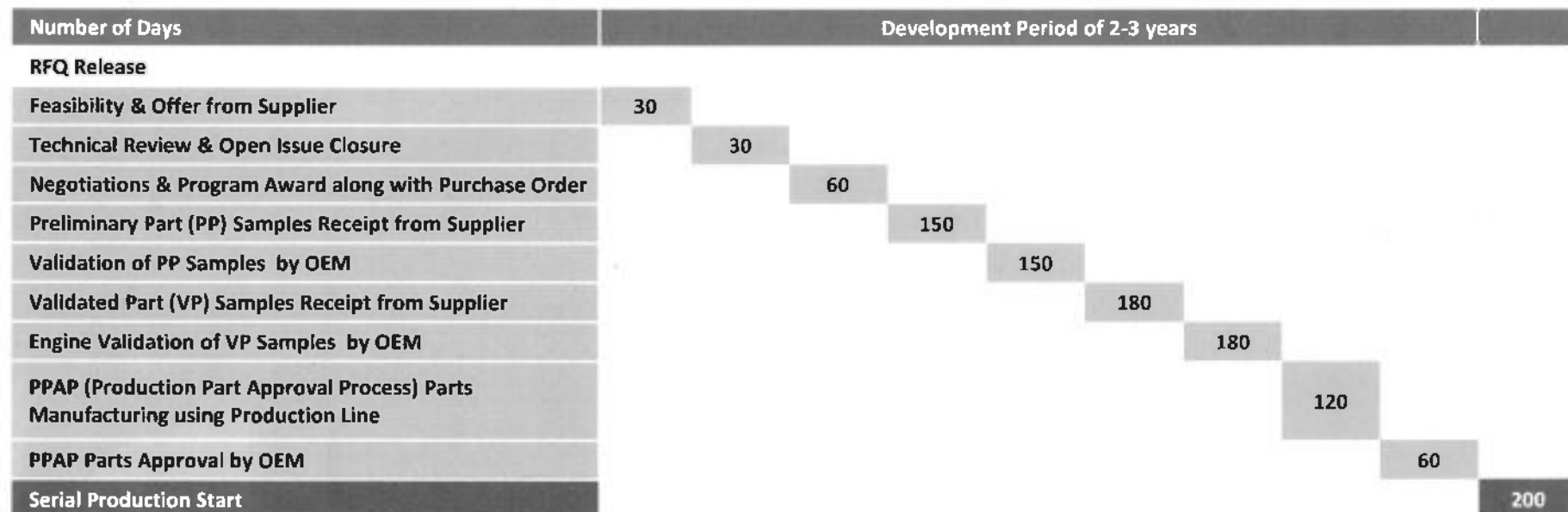

# BUSINESS MODEL

## PCL: REVENUE & MARGINS



**SALES REALISATION OF MACHINED CAMSHAFT IS 2.5X - 3.0X TIMES OF CAMSHAFT CASTING**

**HIGHER SALES OF MACHINED CAMSHAFTS TO DRIVE MARGIN EXPANSION**

### GEOGRAPHICAL DISTRIBUTION OF SALES



## DISCUSSION SUMMARY



❑ COMPANY OVERVIEW

❑ BUSINESS MODEL

❑ COMPETITIVE ADVANTAGES

❑ BUSINESS STRATEGY & OUTLOOK

❑ FINANCIAL OVERVIEW &  
SHAREHOLDING STRUCTURE



## COMPETITIVE ADVANTAGE

### STATE OF ART MANUFACTURING FACILITIES & ENGINEERING EXPERTISE



#### INDIA FACILITIES

Facility	Description	Installed Capacity – FY16 (Million Units p.a.)
EOU Unit (Solapur, Maharashtra)	<ul style="list-style-type: none"> <li>4 Foundries</li> <li>2 Machine shops</li> </ul>	<ul style="list-style-type: none"> <li>Foundry: 12.00</li> <li>Machine Shop: 1.86</li> </ul>
Domestic Unit (Solapur, Maharashtra)	<ul style="list-style-type: none"> <li>1 Foundry</li> <li>1 Machine shop</li> </ul>	<ul style="list-style-type: none"> <li>Foundry: 1.38</li> <li>Machine Shop: 0.36</li> </ul>

#### CHINA FACILITIES – THROUGH STRATEGIC JVs

Joint Venture	Installed Capacity – FY16 (Million Units p.a.)
Ningbo Shenglong PCL Camshafts Company Limited (“NSPCCL”) PCL’s stake: 22.5%	<ul style="list-style-type: none"> <li>Machine Shop: 1.50</li> </ul>
PCL Shenglong (Huzhou) Specialized Casting Company Limited (“PCLSHSCCL”) PCL’s stake: 40%	<ul style="list-style-type: none"> <li>Foundry: 4.00</li> </ul>

#### KEY RAW MATERIALS

- Resin Coated Sand
- Pig Iron
- MS Scrap

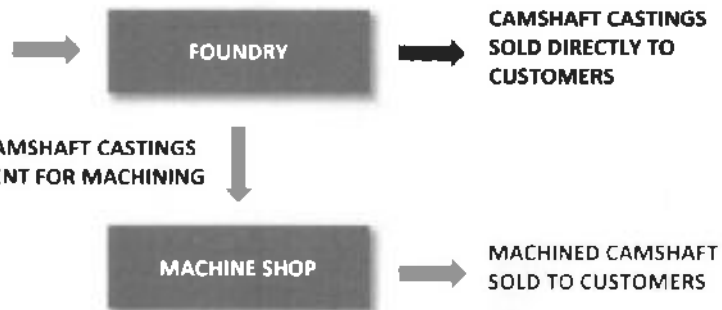

#### STATE OF ART MANUFACTURING FACILITY:

- Foundries - Latest technology enabling cost-competitive and non-polluting manufacturing
- Machine Shops - World class machinery equipments recognized by global OEMs
- Low rejection rate -
  - Internal rejection rate of 7-9%
  - Customer rejection rate of 5,000 – 10,000 ppm